

## VDW 3015

### Options Optionen

- > Hydraulic or electric shifting  
Hydraulische oder elektrische  
Schaltung
- > Mounting plates  
Montageplatten
- > Speed measuring  
Drehzahlmessung
- > Pendulum part  
Kardangelenk
- > Path measurement for relative  
adjustment  
Wegmessung für  
Relativverschiebung

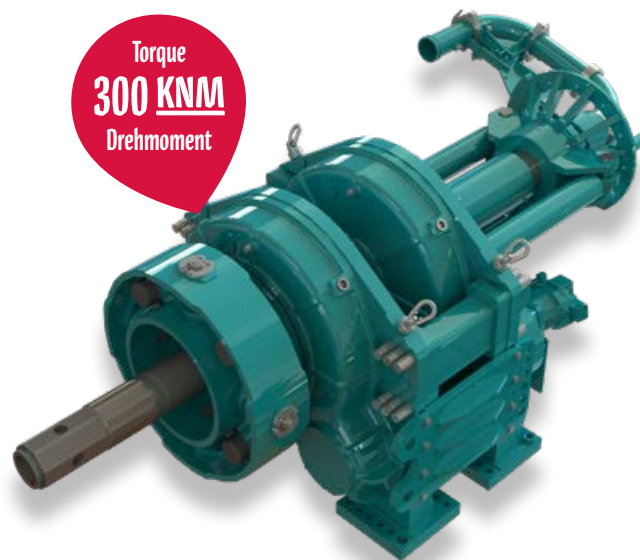

X-SERIES



VIBRATION HEADS



CORING HEADS



DOUBLE HEAD  
DRILLING SYSTEMS



ROTARY HEADS  
FOR PILE RIGS



DRILLING  
ACCESSORIES

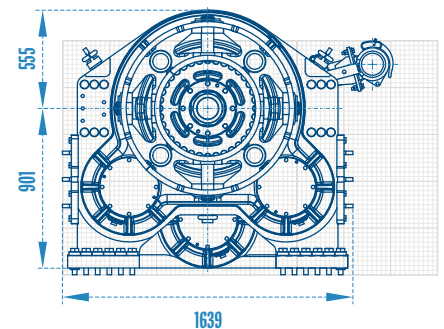
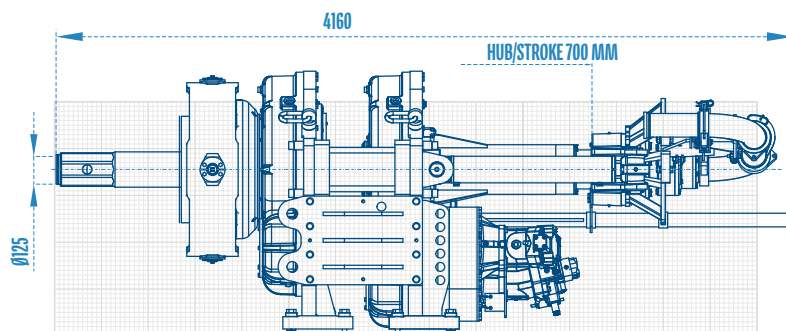

Technical Specifications are subject to modifications without prior notice and incurring responsibility for machines previously sold. The shown machines may have optional equipment. Technical data do not consider power losses. Error misprints reserved. / Technische Änderungen ohne Vorankündigung und Verpflichtung gegenüber früher gelieferten Geräten. Die abgebildeten Geräte können Sonderausstattungen haben. Technische Daten ohne Berücksichtigung des Wirkungsgrades. Irrtum und Druckfehler vorbehalten.



8600 kg **Weight** Gewicht · 850 kN **Traction** Zugkraft

**Gear box 1 / Casing VDW 3015**  
**Getriebe 1 / Rohr**

**Gear box 2 / Auger VDW 3015**  
**Getriebe 2 / Schnecke**

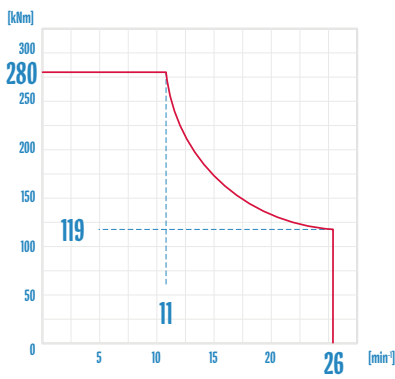

p = 320 bar & Q = 400 l/min

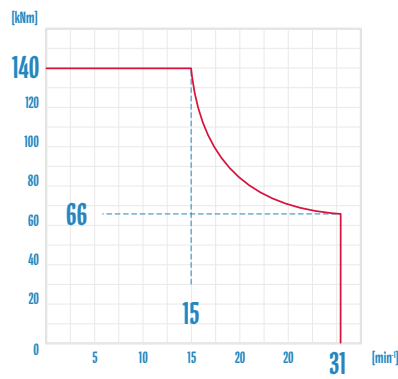

p = 320 bar & Q = 400 l/min

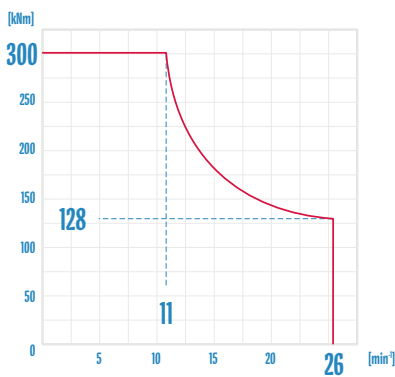

p = 345 bar & Q = 400 l/min

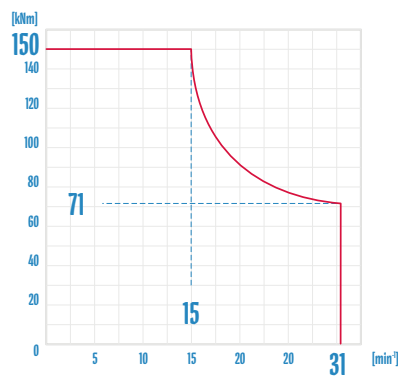

p = 345 bar & Q = 400 l/min